



Features

- Low forward voltage drop
- High reverse voltage
- Hermetic metal cases with ceramic insulators

Typical Applications

- All purpose high power rectifier diodes
- High power resistance welding equipment
- Non-controllable and half-controllable rectifiers
- Controlled rectifiers

Part No. Y100ZPG-ZT100cT		
I_{F(AV)}	5650A	
V_{RRM}	4500V	5000V

SYMBOL	CHARACTERISTIC	TEST CONDITIONS		T _j (°C)	VALUE			UNIT
					Min	Type	Max	
I _{F(AV)}	Mean forward current	180° half sine wave 50Hz Double side cooled,	T _C =85°C	150			5650	A
V _{RRM}	Repetitive peak reverse voltage	tp=10ms		150	4300		5000	V
I _{RRM}	Repetitive peak current	at V _{RRM}		150			300	mA
I _{FSM}	Surge forward current	10ms half sine wave		150			60	kA
I ² t	I ² t for fusing coordination	V _R =0.6V _{RRM}						18000
V _{FO}	Threshold voltage			150			0.91	V
r _F	Forward slope resistance							0.10
V _{FM}	Peak forward voltage	I _{FM} =5000A, F=108kN		25			2.00	V
Q _{rr}	Recovery charge	I _{FM} =2000A, tp=4000μs, di/dt=-20A/μs, V _R =100V		150		9000		μC
R _{th(j-c)}	Thermal resistance Junction to case	At 180° sine double side cooled Clamping force 108kN					0.0050	°C /W
R _{th(c-h)}	Thermal resistance case to heat sink						0.0015	
F _m	Mounting force				81		108	kN
T _{vj}	Junction temperature				-40		150	°C
T _{stg}	Stored temperature				-40		160	°C
W _i	Weight					2000		g
Outline	ZT100cT							

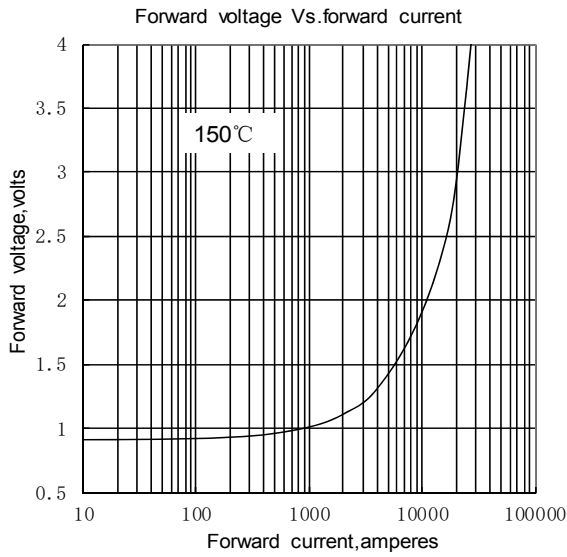

Fig.1

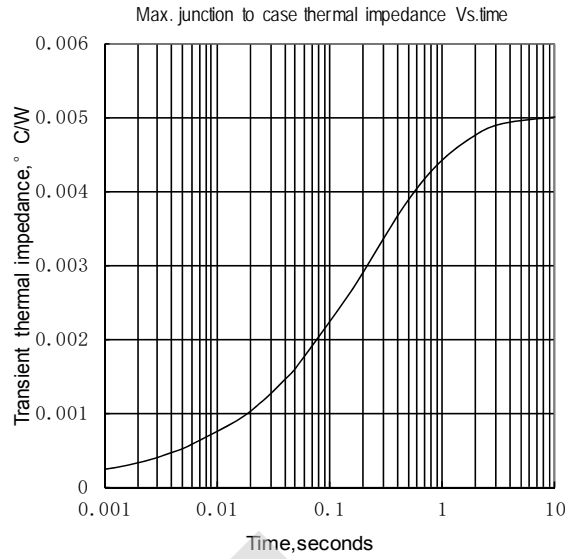

Fig.2

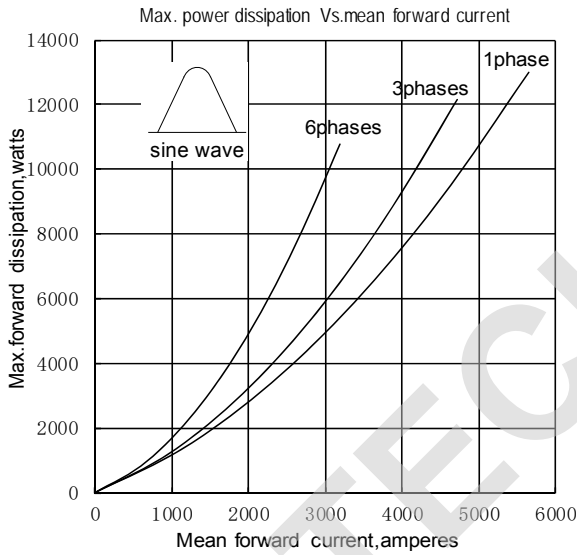

Fig.3

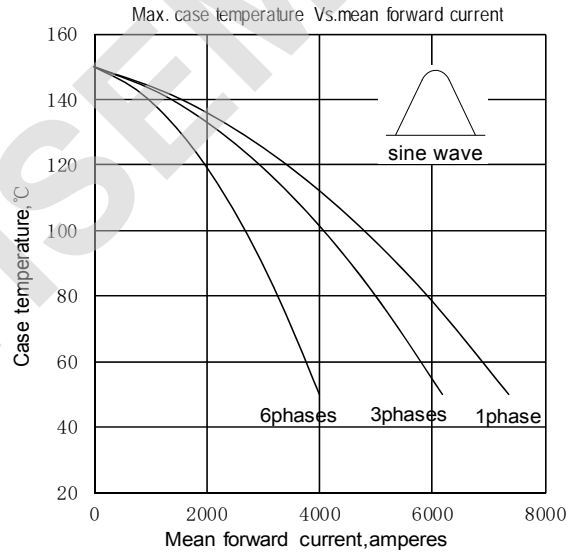

Fig.4

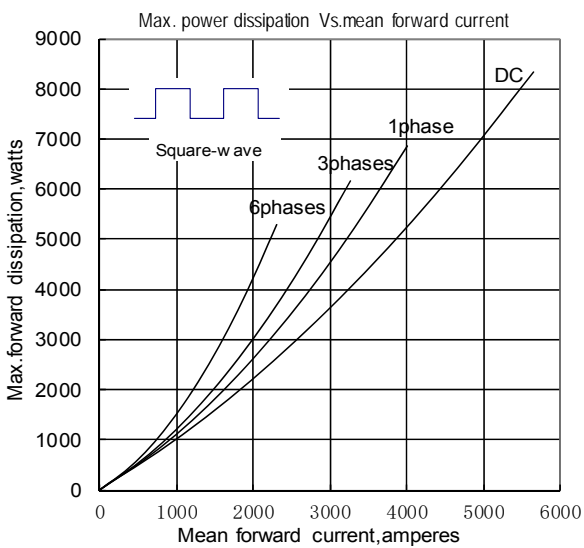

Fig.5

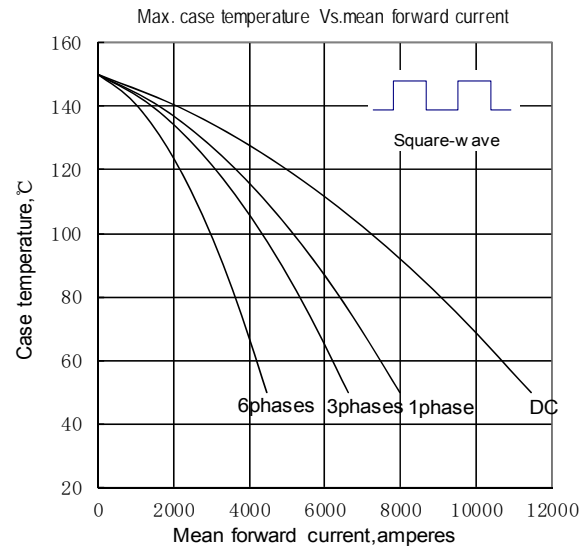

Fig.6

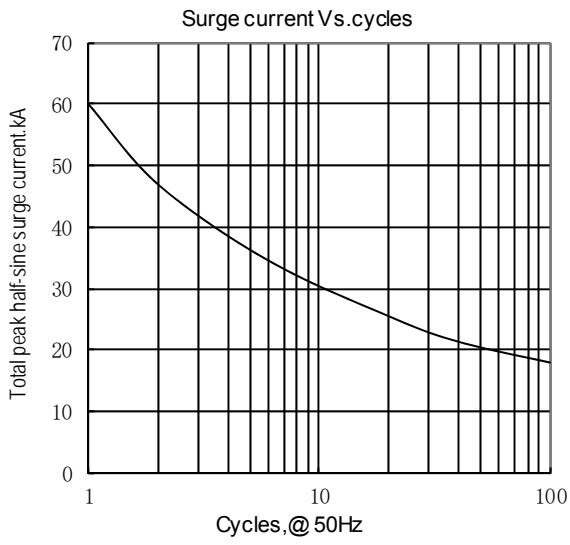

Fig7

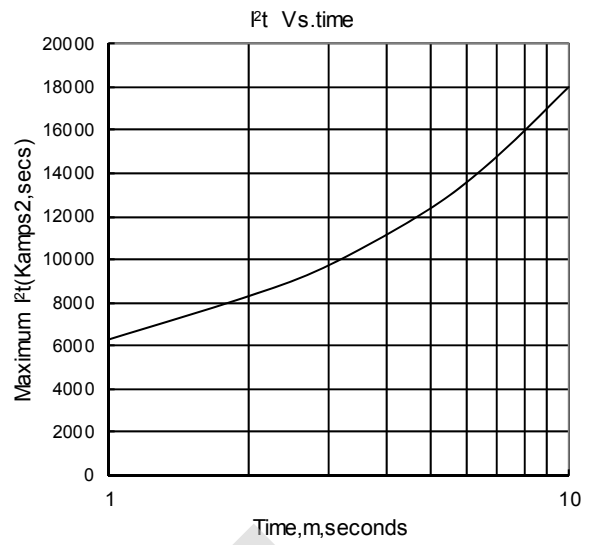
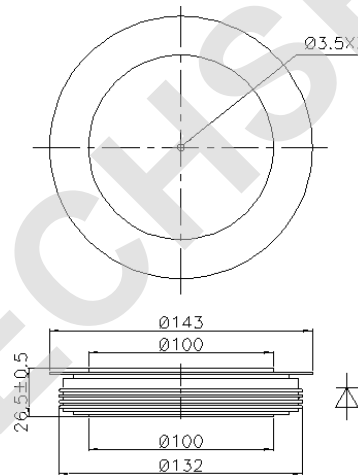

Fig8

Outline:



TECHSEM reserves the right to change specifications without notice.