

Features

- Interdigitated amplifying gates
- Fast turn-on and high di/dt
- Low switching losses

Typical Applications

- Pulsed power
- Ignitron Replacement

Part No. H150KMN-KT140dT

I_{PK}	330kA
V_{DRM}, V_{RRM}	5000V 5200V
	5500V

SYMBOL	CHARACTERISTIC	TEST CONDITIONS	T _J (°C)	VALUE			UNIT
				Min	Type	Max	
I _{pk}	Pulse peak on-state current	Single pulse sine wave tp: 500µs	110			330	kA
I _{T(AV)}	Mean on-state current	180° half sine wave 50Hz Double side cooled, T _C =70°C	110			6500	A
V _{DRM} V _{RRM}	Repetitive peak off-state voltage Repetitive peak reverse voltage	tp=10ms	110	5000		5500	V
I _{DRM} I _{RRM}	Repetitive peak current	at V _{DRM} at V _{RRM}	110			500	mA
I _{TSM}	Surge on-state current	10ms half sine wave	110			80	kA
I ² t	I ² t for fusing coordination	V _R =0.6V _{RRM}				32000	A ² s*10 ³
V _{TM}	Peak on-state voltage	I _{TM} =5000A, F=120kN, tp=10ms	25			2.00	V
dv/dt	Critical rate of rise of off-state voltage	V _{DM} =0.67V _{DRM}	110			2000	V/µs
di/dt	Critical rate of rise of on-state current	Gate pulse t _r ≤ 0.5µs I _{GM} =1.5A	110			3000	A/µs
Q _{rr}	Recovery charge	I _{TM} =2000A, tp=4000µs, di/dt=-20A/µs, V _R =100V	110		17500		µC
I _{GT}	Gate trigger current	V _A =12V, I _A =1A	25	40		300	mA
V _{GT}	Gate trigger voltage			0.8		3.5	V
I _H	Holding current			20		1000	mA
I _L	Latching current					1000	mA
V _{GD}	Non-trigger gate voltage	V _{DM} =67%V _{DRM}	110	0.25			V
R _{th(j-c)}	Thermal resistance Junction to case	At 180° sine double side cooled Clamping force 120 kN				0.0028	°C /W
R _{th(c-h)}	Thermal resistance case to heat sink					0.0008	°C /W
F _m	Mounting force			110		140	kN
T _{vj}	Junction temperature			-40		110	°C
T _{stg}	Stored temperature			-40		140	°C
W _t	Weight				4000		g
Outline	KT140dT						

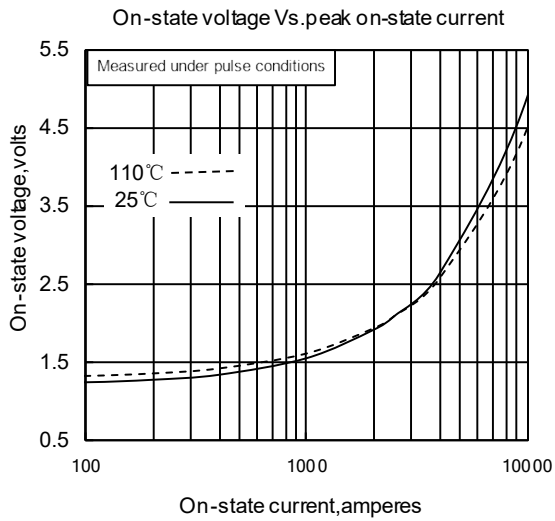

Fig. 1

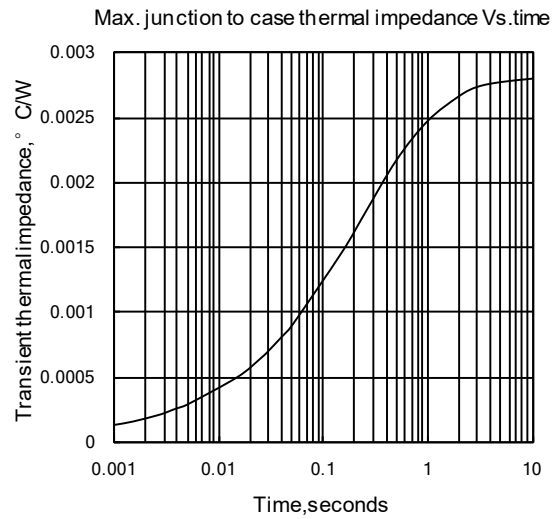

Fig. 2

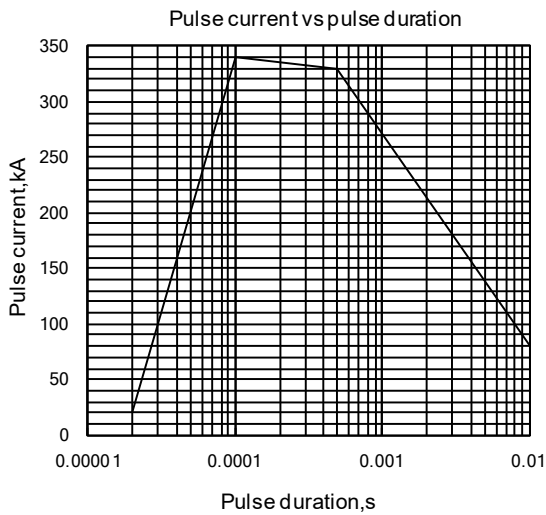

Fig. 3

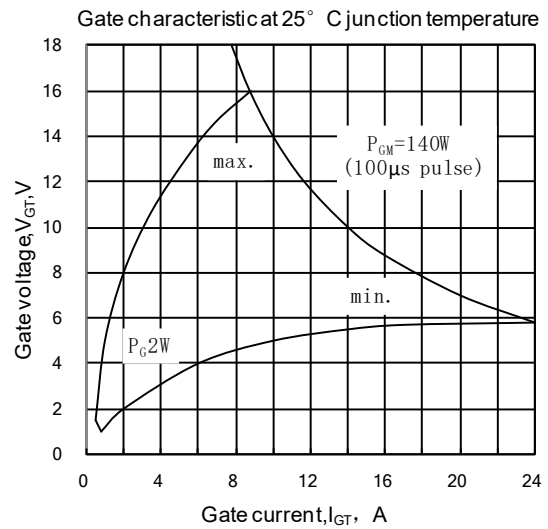

Fig. 4

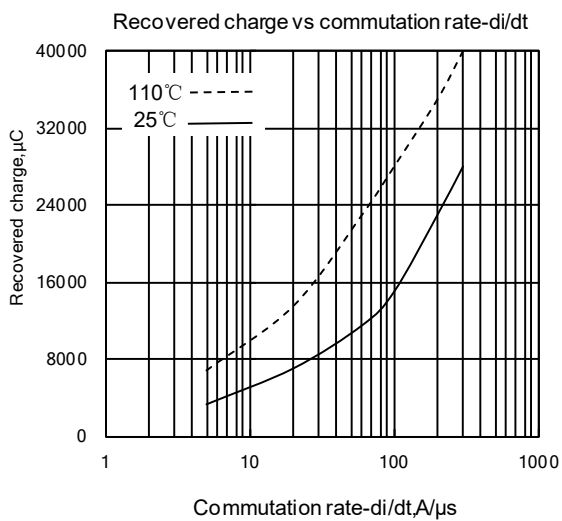

Fig. 5

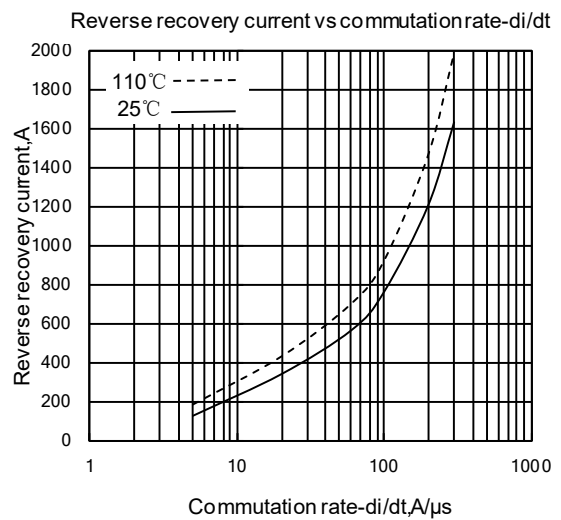
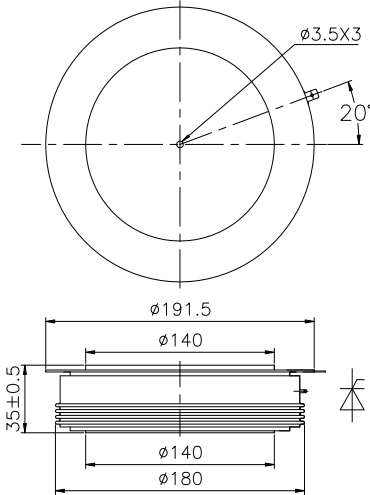

Fig. 6

Outline:



TECHSEM reserves the right to change specifications without notice.