

Features:

- n Isolated mounting base 2500V~
- n Pressure contact technology with Increased power cycling capability
- n Space and weight saving

Typical Applications:

- n Inverter
- n Inductive heating
- n Chopper

V _{RRM} , V _{DRM}	Type & Outline	
600V	MKx150-06-413F3D	MHx150-06-413F3D
800V	MKx150-08-413F3D	MHx150-08-413F3D
1000V	MKx150-10-413F3D	MHx150-10-413F3D
1200V	MKx150-12-413F3D	MHx150-12-413F3D
1400V	MKx150-14-413F3D	MHx150-14-413F3D
1600V	MKx150-16-413F3D	MHx150-16-413F3D
1800V	MKx150-18-413F3D	MHx150-18-413F3D
1800V	MK150-18-413F3DG	

MKx stands for any type of **MKC, MKA, MKK**
 MHx stands for any type of **MHC, MHA, MHK**

SYMBOL	CHARACTERISTIC	TEST CONDITIONS	T _i (°C)	VALUE			UNIT
				Min	Type	Max	
I _{T(AV)}	Mean on-state current	180° half sine wave 50Hz Single side cooled, T _c =85°C	125			150	A
I _{T(RMS)}	RMS on-state current					236	A
I _{DRM} I _{RRM}	Repetitive peak current	at V _{DRM} at V _{RRM}	125			50	mA
I _{TSM}	Surge on-state current	10ms half sine wave V _R =60%V _{RRM}	125			3.4	kA
I ² t	I ² t for fusing coordination					58	10 ³ A ² s
V _{TO}	Threshold voltage		125			1.78	V
r _T	On-state slope resistance					0.70	m
V _{TM}	Peak on-state voltage	I _{TM} =450A	25			2.65	V
dv/dt	Critical rate of rise of off-state voltage	V _{DM} =67%V _{DRM}	125			800	V/μs
di/dt	Critical rate of rise of on-state current	Gate source 1.5A t _r ≤0.5μs Repetitive	125			200	A/μs
t _q	Circuit commutated turn-off time	I _{TM} =200A, t _p =4000μs, V _R =100V dv/dt=30V/μs, di/dt=-20A/μs	125	20		40	μs
			25	6		16	μs
I _{GT}	Gate trigger current	V _A =12V, I _A =1A	25	30		180	mA
V _{GT}	Gate trigger voltage			0.8		2.5	V
I _H	Holding current			20		200	mA
I _L	Latching current					1000	mA
V _{GD}	Non-trigger gate voltage	V _{DM} = 67%V _{DRM}	125			0.2	V
R _{th(j-c)}	Thermal resistance Junction to case	Single side cooled per chip				0.130	°C /W
R _{th(c-h)}	Thermal resistance case to heatsink	Single side cooled per chip				0.030	°C /W
V _{iso}	Isolation voltage	50Hz, R.M.S, t=1min, I _{iso} : 1mA(MAX)		2500			V
F _m	Terminal connection torque(M8)			10.0		12.0	N·m
	Mounting torque(M6)			4.5		6.0	N·m
T _{vj}	Junction temperature			-40		125	°C
T _{stg}	Stored temperature			-40		125	°C
W _t	Weight				770		g
Outline	413F3D						

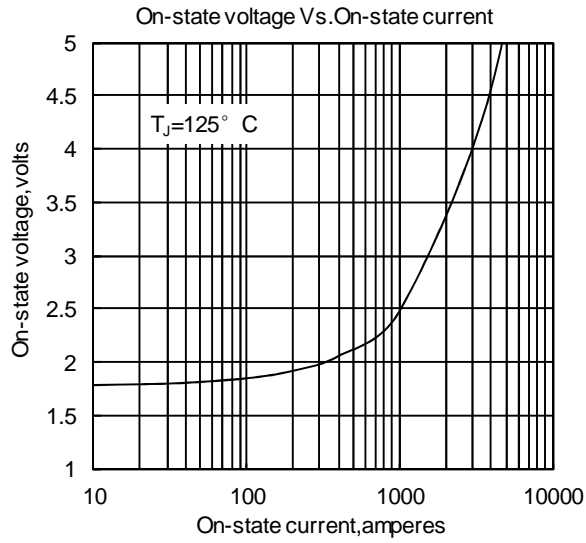

Fig.1

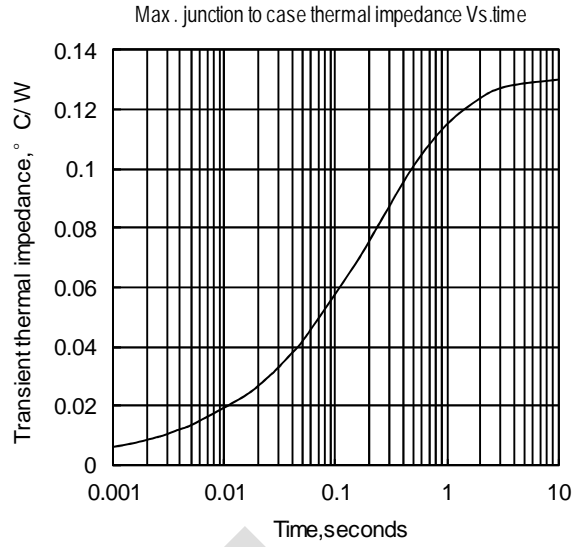

Fig.2

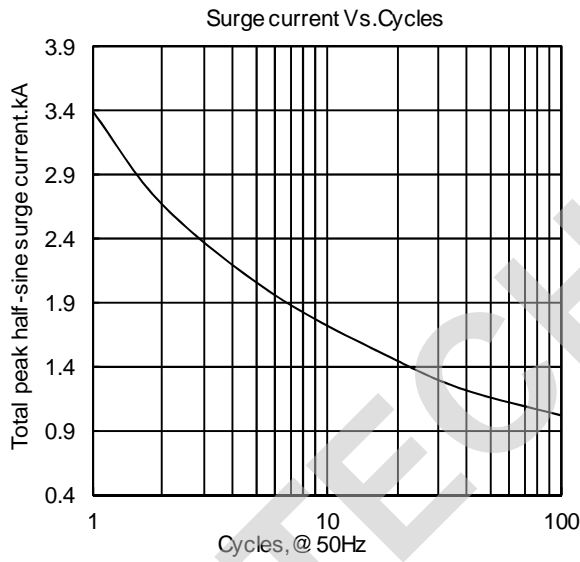

Fig.3

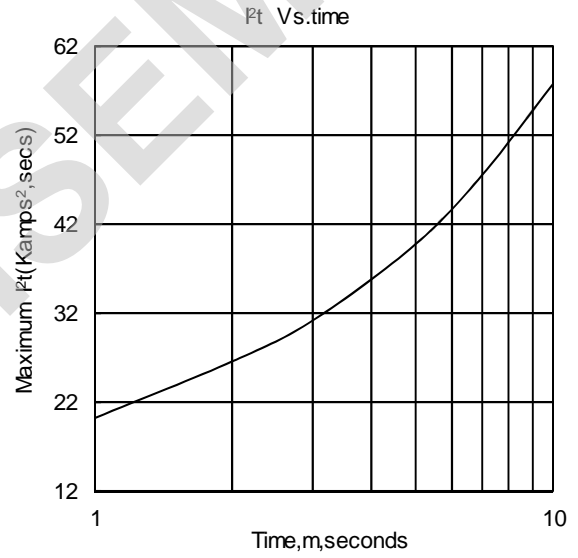

Fig.4

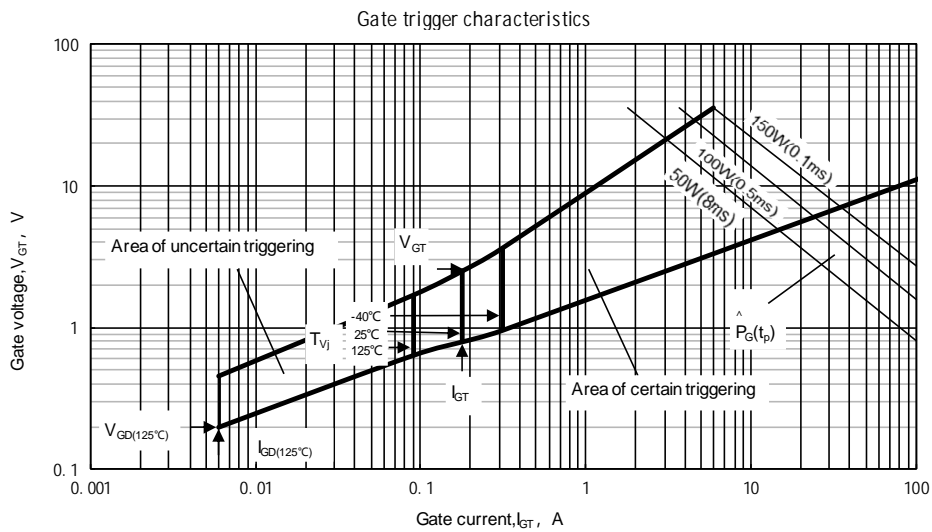
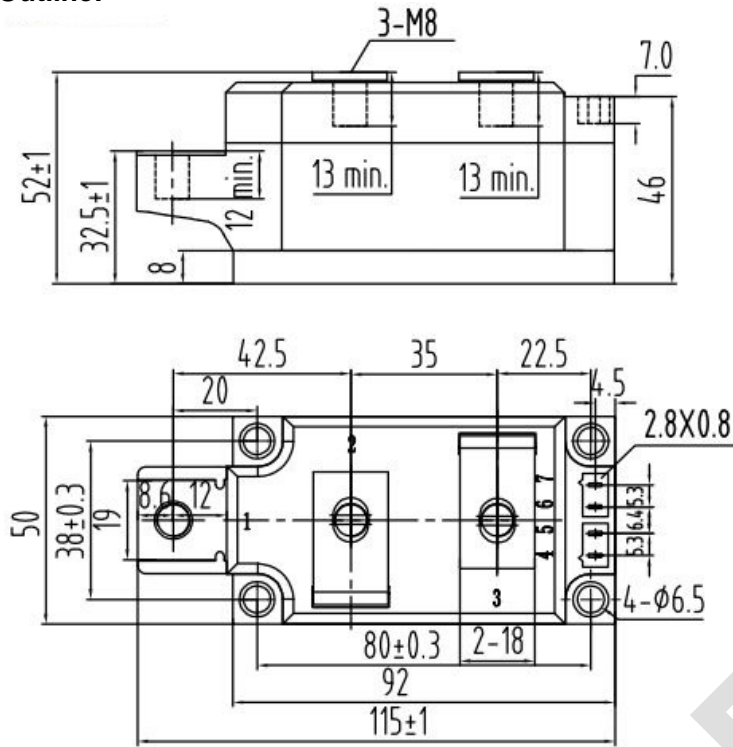

Fig.5

Outline:



Unmarked dimensional tolerance: ±0.5mm

TECHSEM reserves the right to change specifications without notice.

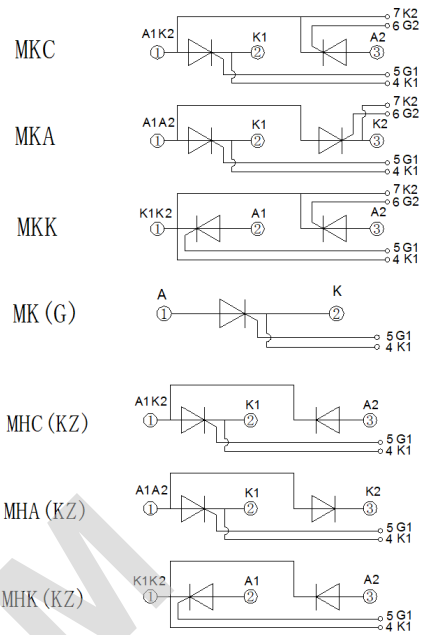

TECHSEM