

**Features:**

- n Isolated mounting base 3000V~
- n Solder joint technology with increased power cycling capability
- n Space and weight saving

**Typical Applications:**

- n Various rectifiers
- n DC supply for PWM inverter

V <sub>RRM</sub>	Type & Outline
600V	MDC182-06-229H3
800V	MDC182-08-229H3
1000V	MDC182-10-229H3
1200V	MDC182-12-229H3
1400V	MDC182-14-229H3
1600V	MDC182-16-229H3
1800V	MDC182-18-229H3

SYMBOL	CHARACTERISTIC	TEST CONDITIONS	T <sub>j</sub> (°C)	VALUE			UNIT
				Min	Type	Max	
I <sub>F(AV)</sub>	Mean forward current	180° half sine wave 50Hz Single side cooled, T <sub>c</sub> =100°C	150			182	A
I <sub>F(RMS)</sub>	RMS forward current		150			286	A
I <sub>RRM</sub>	Repetitive peak current	at V <sub>RRM</sub>	150			12	mA
I <sub>FSM</sub>	Surge forward current	10ms half sine wave V <sub>R</sub> =0.6V <sub>RRM</sub>	150			4	kA
I <sup>2</sup> t	I <sup>2</sup> t for fusing coordination					84.1	A <sup>2</sup> s*10 <sup>3</sup>
V <sub>FO</sub>	Threshold voltage		150			0.83	V
r <sub>F</sub>	Forward slope resistance					1.2	mΩ
V <sub>FM</sub>	Peak forward voltage	I <sub>FM</sub> =550A	25			1.55	V
R <sub>th(j-c)</sub>	Thermal resistance Junction to case	Single side cooled per chip				0.19	°C/W
R <sub>th(c-h)</sub>	Thermal resistance case to heatsink	Single side cooled per chip				0.08	°C/W
V <sub>iso</sub>	Isolation voltage	50Hz, R.M.S, t=1min, I <sub>iso</sub> :1mA(max)		3000			V
F <sub>m</sub>	Terminal connection torque(M6)			4.5		6	N·m
	Mounting torque(M6)			4.5		6	N·m
T <sub>vj</sub>	Junction temperature			-40		150	°C
T <sub>stg</sub>	Stored temperature			-40		125	°C
W <sub>t</sub>	Weight				165		g
Outline	229H3						

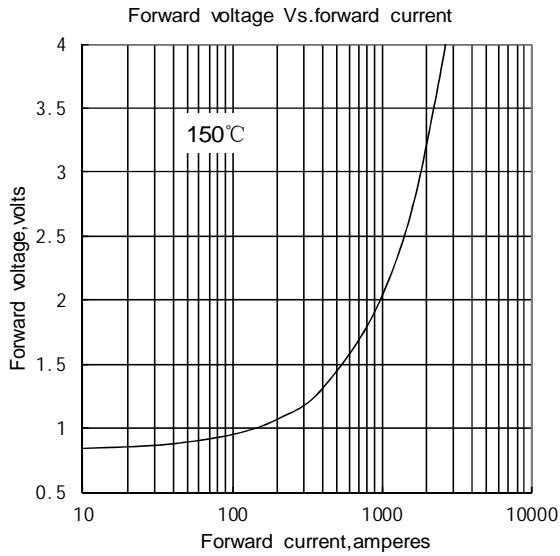

Fig1

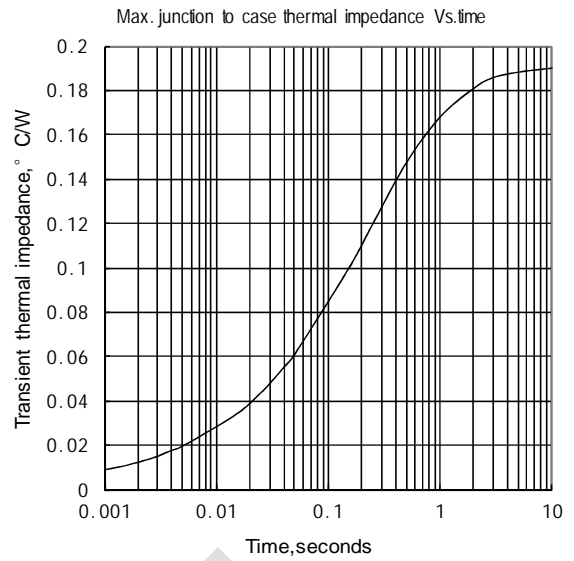

Fig2

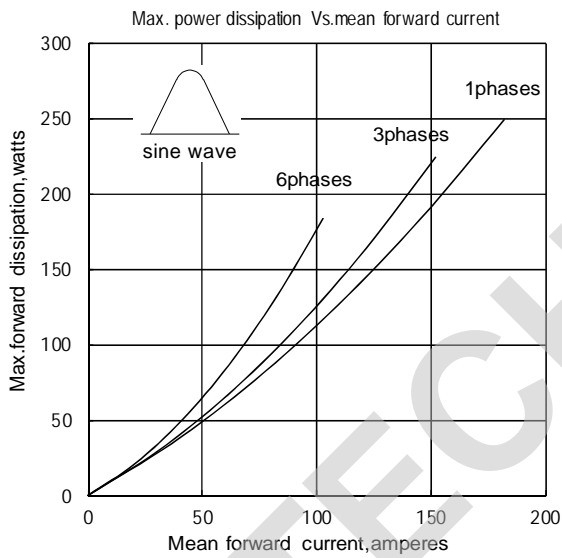

Fig3

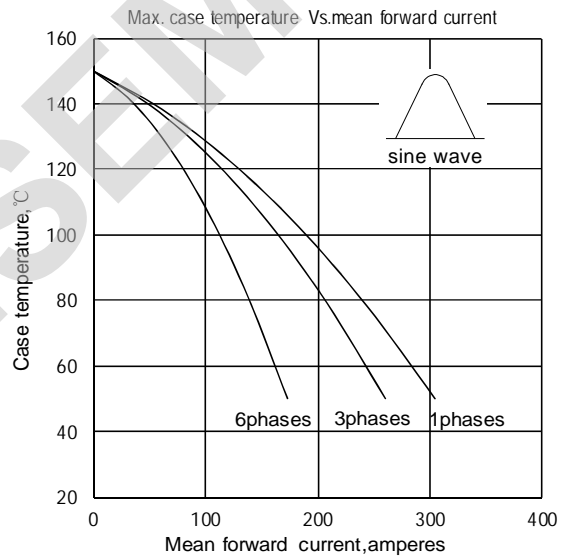

Fig4

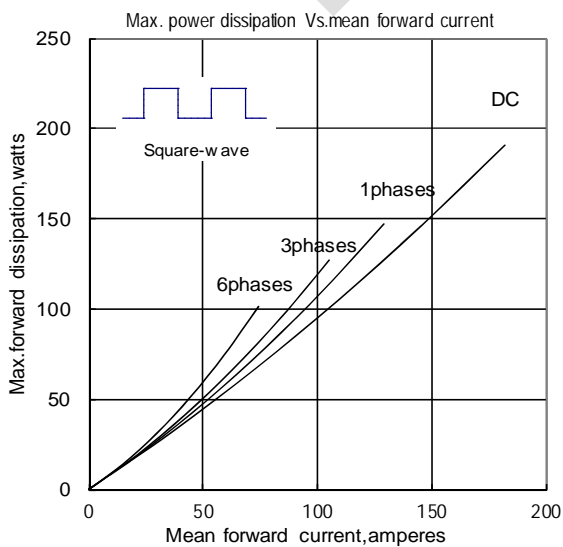

Fig5

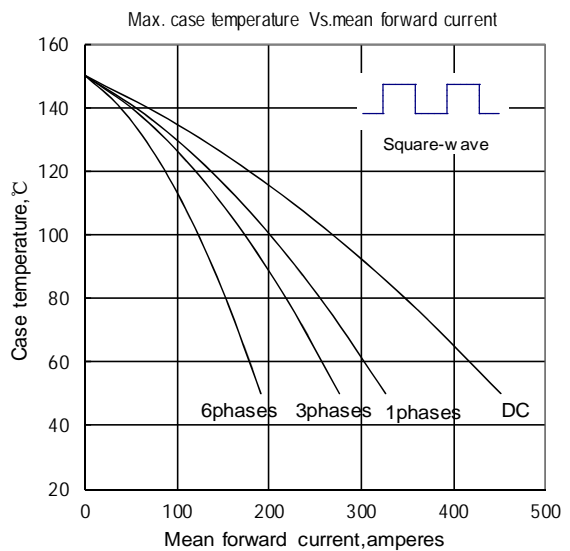

Fig6

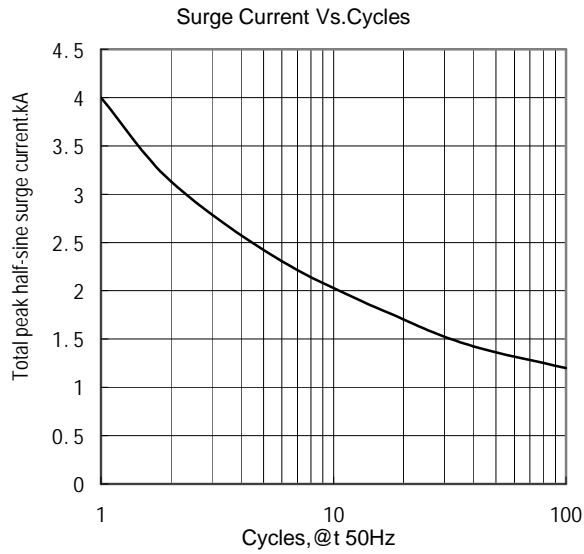

Fig7

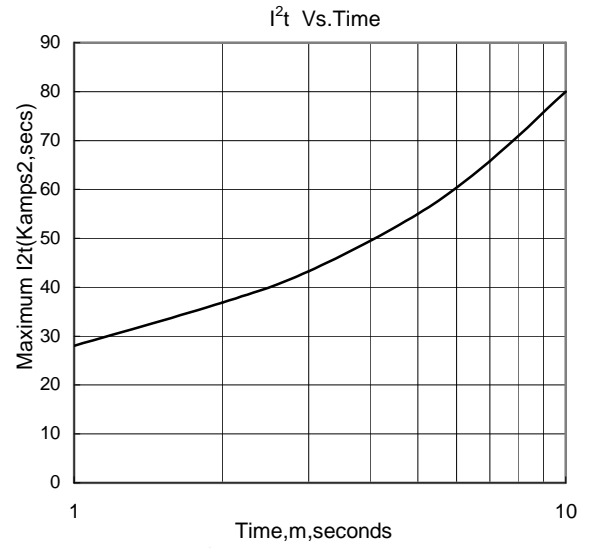
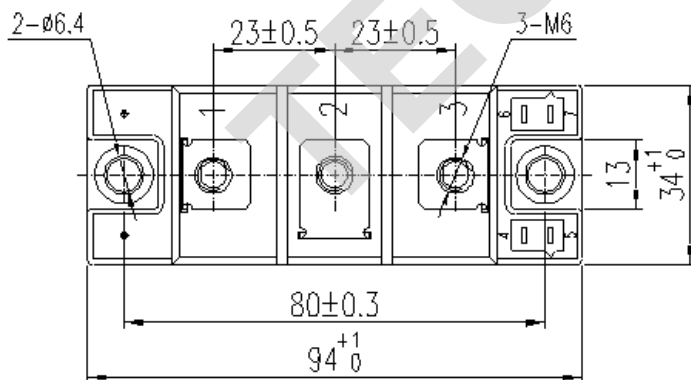
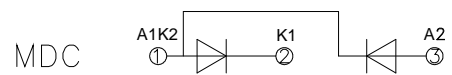
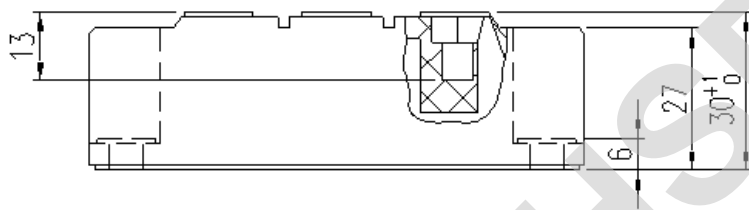

Fig8

Outline:



Unmarked dimensional tolerance: ±0.5mm