

**Features:**

- n Isolated mounting base 3000V~
- n Solder joint technology with increased power cycling capability
- n Space and weight saving

**Typical Applications:**

- n Various rectifiers
- n DC supply for PWM inverter

$V_{RRM}$	Type & Outline
600V	MDC90-06-224H3
800V	MDC90-08-224H3
1000V	MDC90-10-224H3
1200V	MDC90-12-224H3
1400V	MDC90-14-224H3
1600V	MDC90-16-224H3
1800V	MDC90-18-224H3

SYMBOL	CHARACTERISTIC	TEST CONDITIONS	$T_j(^{\circ}\text{C})$	VALUE			UNIT
				Min	Type	Max	
$I_{F(AV)}$	Mean forward current	180° half sine wave 50Hz Single side cooled, $T_c=100^{\circ}\text{C}$	150			90	A
$I_{F(RMS)}$	RMS forward current		150			141	A
$I_{RRM}$	Repetitive peak current	at $V_{RRM}$	150			8	mA
$I_{FSM}$	Surge forward current	10ms half sine wave $V_R=0.6V_{RRM}$	150			2.0	kA
$I^2t$	$I^2t$ for fusing coordination					20.0	$\text{A}^2\text{s}\cdot 10^3$
$V_{FO}$	Threshold voltage		150			0.80	V
$r_F$	Forward slope resistance					1.70	m $\Omega$
$V_{FM}$	Peak forward voltage	$I_{FM}=270\text{A}$	25			1.50	V
$R_{th(j-c)}$	Thermal resistance Junction to case	Single side cooled per chip				0.47	$^{\circ}\text{C}/\text{W}$
$R_{th(c-h)}$	Thermal resistance case to heatsink	Single side cooled per chip				0.20	$^{\circ}\text{C}/\text{W}$
$V_{iso}$	Isolation voltage	50Hz, R.M.S, $t=1\text{min}$ , $I_{iso}:1\text{mA}(\text{max})$		3000			V
$F_m$	Terminal connection torque(M5)			2.5		4.0	N·m
	Mounting torque(M6)			4.5		6.0	N·m
$T_{vj}$	Junction temperature			-40		150	$^{\circ}\text{C}$
$T_{stg}$	Stored temperature			-40		125	$^{\circ}\text{C}$
$W_t$	Weight				100		g
Outline	224H3						

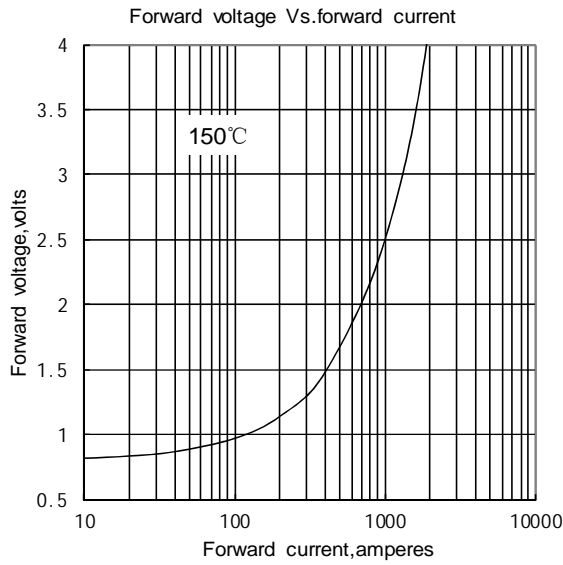

Fig1

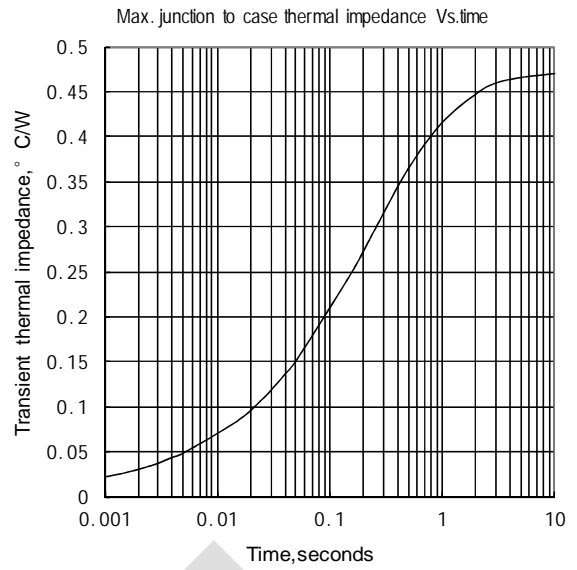

Fig2

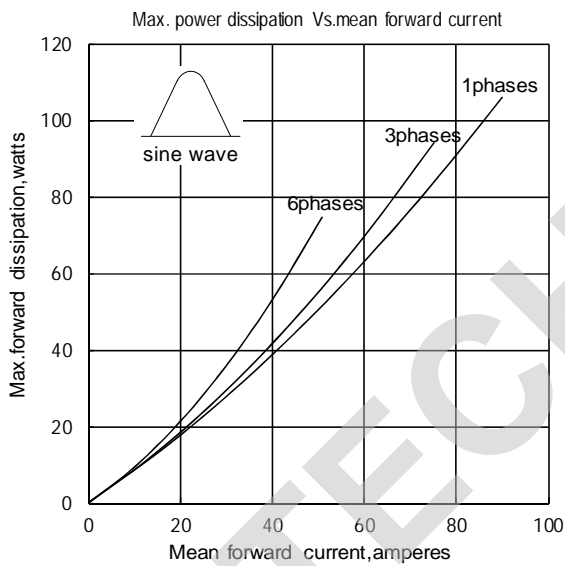

Fig3

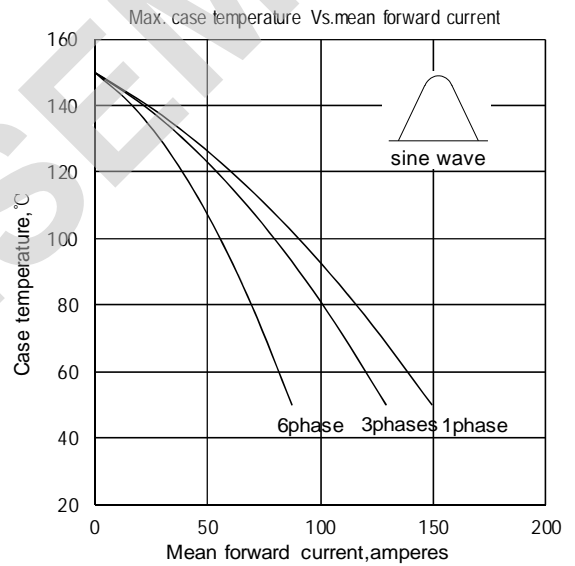

Fig4

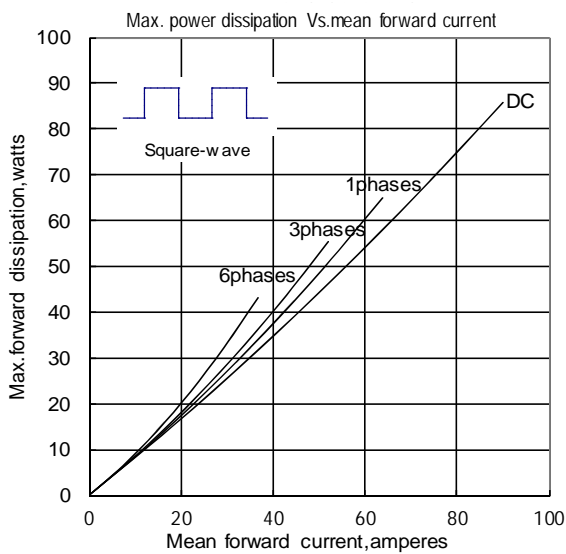

Fig5

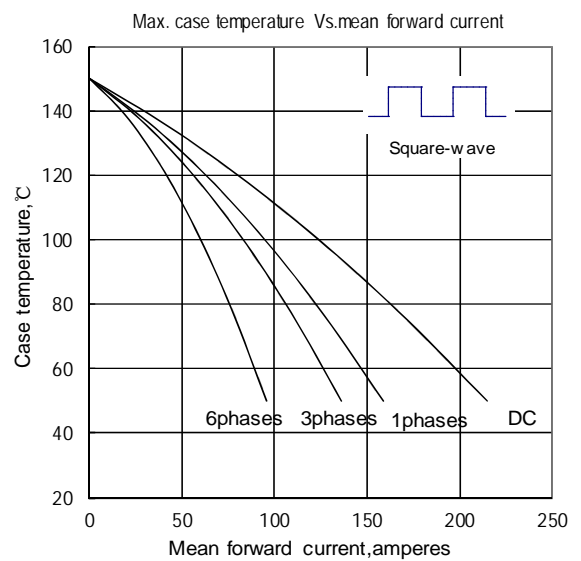

Fig6

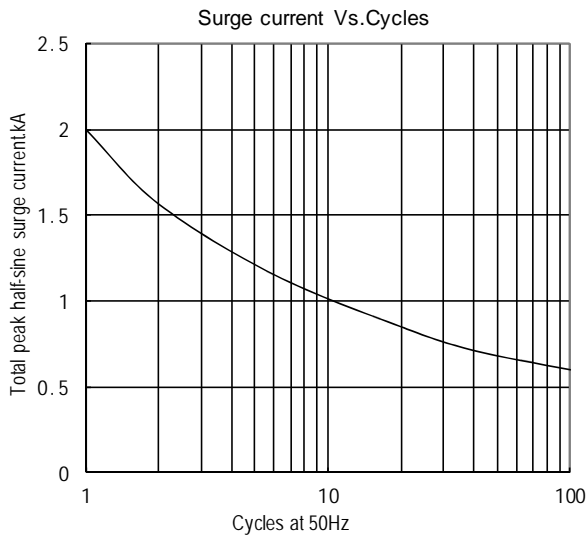

Fig.7

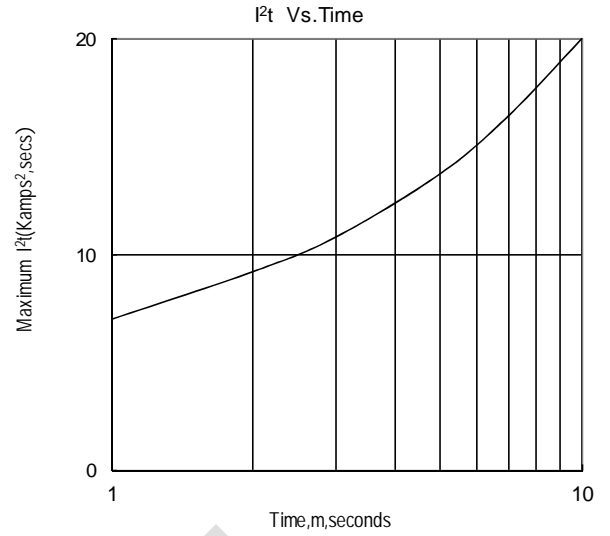
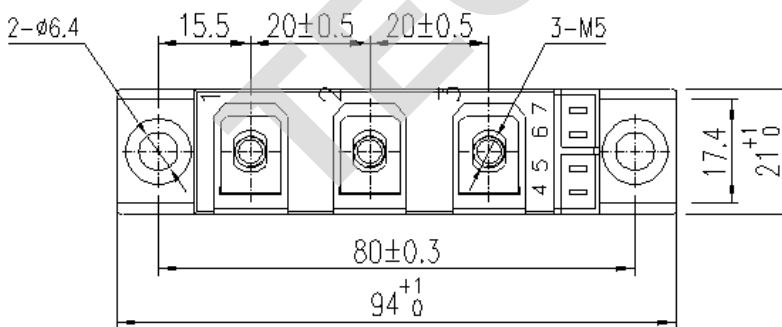
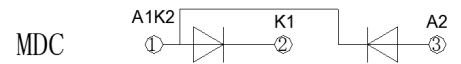
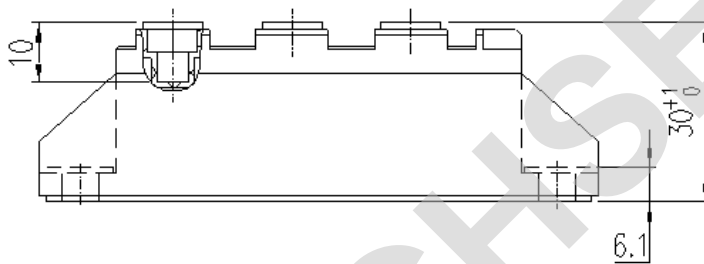

Fig.8

Outline:



Unmarked dimensional tolerance: ±0.5mm