



Features:

- n Isolated mounting base 2500V~
- n Solder joint technology with Increased power cycling capability
- n Space and weight savings

Typical Applications:

- n DC Power supplies for equipment.
- n DC supply for PWM inverter
- n Inverter Welder

V _{RRM}	Type & Outline
600V	MDQ50-06-232H5
800V	MDQ50-08-232H5
1000V	MDQ50-10-232H5
1200V	MDQ50-12-232H5
1400V	MDQ50-14-232H5
1600V	MDQ50-16-232H5
1800V	MDQ50-18-232H5

SYMBOL	CHARACTERISTIC	TEST CONDITIONS	T _f (°C)	VALUE			UNIT
				Min	Type	Max	
I _O	DC output current	Single-phase full wave rectifying circuit, T _C =100°C	150			50	A
I _{RRM}	Repetitive peak current	at V _{RRM}	150			8	mA
I _{FSM}	Surge forward current	10ms half sine wave	150			0.5	kA
I ² t	I ² T for fusing coordination	V _R =0				1.25	A ² s*10 ³
V _{FO}	Threshold voltage		150			0.7	V
r _F	Forward slop resistance					6.0	m
V _{FM}	Peak forward voltage	I _{FM} =75A	25			1.25	V
R _{th(j-c)}	Thermal resistance Junction to case	Single side cooled, per total				0.24	°C /W
R _{th(c-h)}	Thermal resistance case to heatsink	Single side cooled, per total				0.07	°C /W
V _{iso}	Isolation voltage	50Hz,R.M.S,t=1min,I _{iso} :1mA(max)		2500			V
F _m	Terminal connection torque(M5)				4.0		N·m
	Mounting torque(M5)				4.0		N·m
T _{vj}	Junction temperature			-40		150	°C
T _{stg}	Stored temperature			-40		125	°C
W _t	Weight				120		g
Outline	232H5						

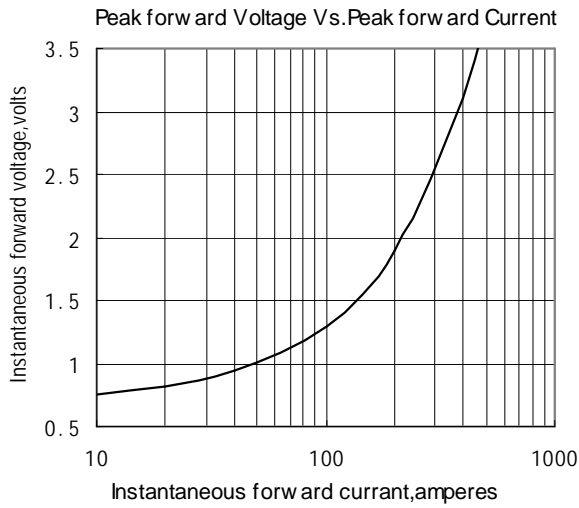

Fig.1

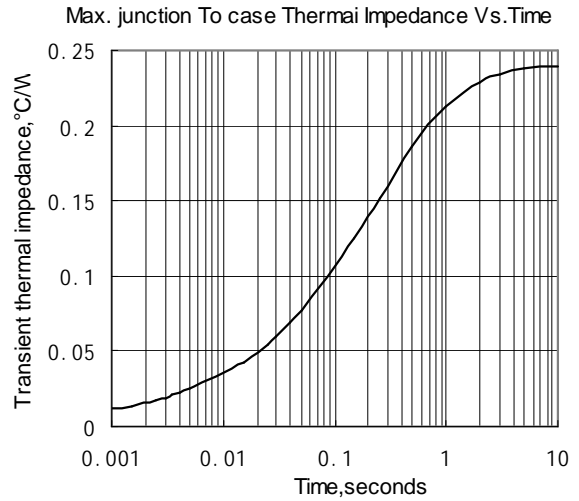

Fig.2

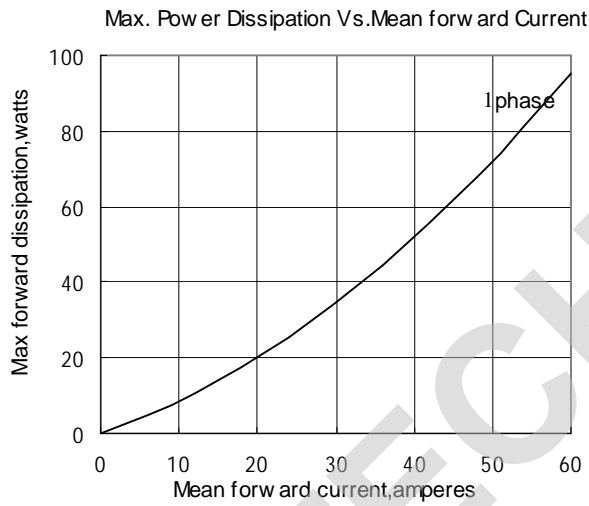

Fig.3

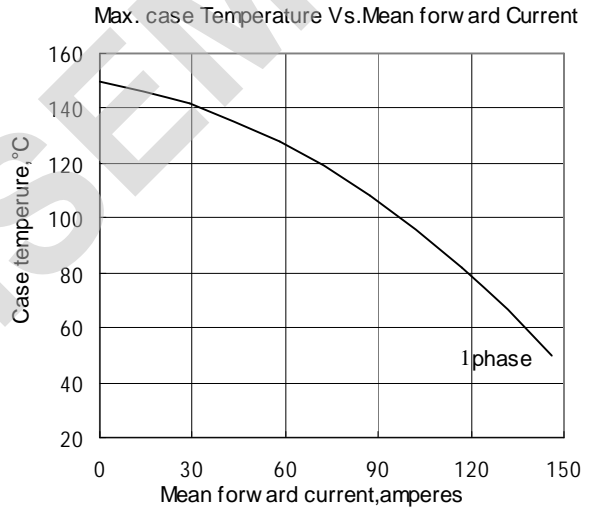

Fig.4

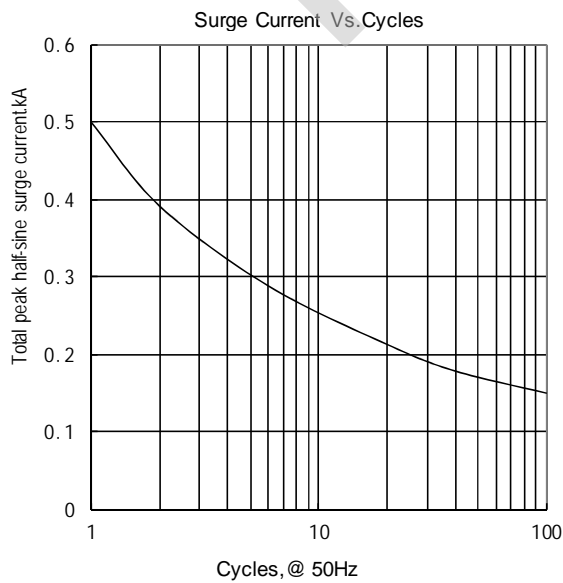

Fig.5

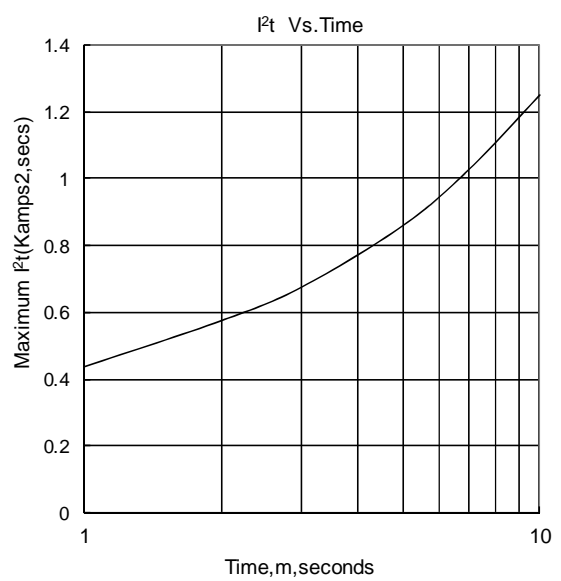
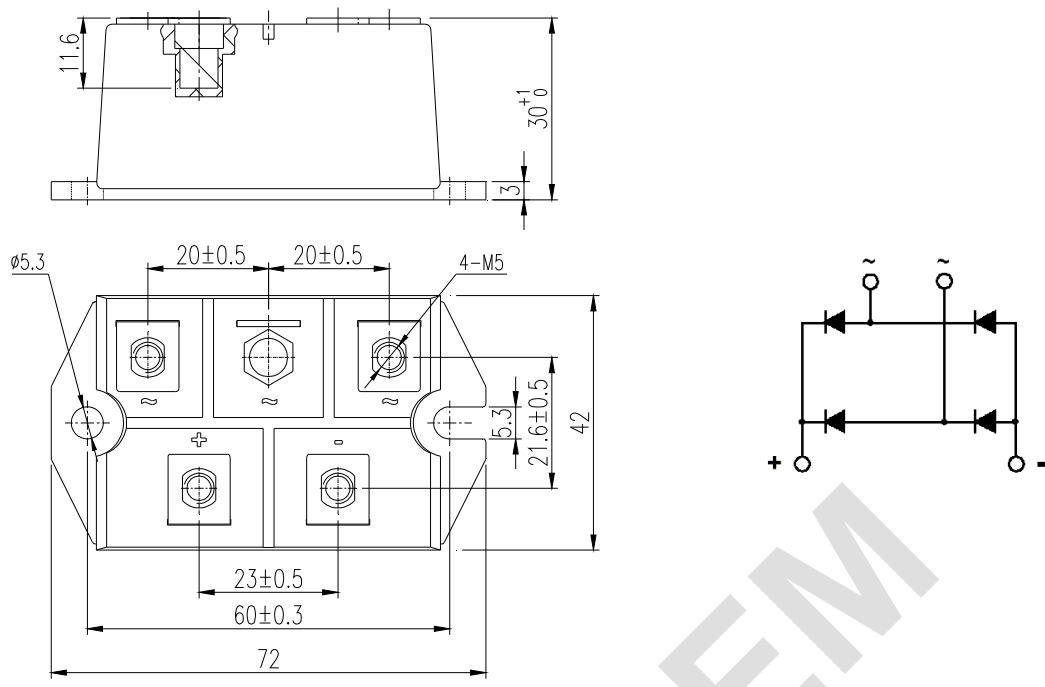

Fig.6

Outline:



Unmarked dimensional tolerance: ± 0.5 mm