

Features :

- n 10us short circuit capability
- n Low switching losses
- n VCE(sat) with Positive temperature coefficient
- n Fast & soft reverse recovery anti-parallel FWD

Typical Applications :

- n Inverter for motor drive(VFD)
- n AC and DC servo drive amplifier
- n Uninterruptible power supply

SYMBOL	CHARACTERISTIC	TEST CONDITIONS	VALUE			UNIT
			Min	Type	Max	
V _{CES}	Collector-Emitter voltage	T _j =25°C			1200	V
V _{GES}	Gate-Emitter voltage	T _j =25°C			±20	V
I _C	Collector current	Continuous@ T _C =125°C			10	A
I _{CP}		T _P =1ms			20	A
P _C	Collector power dissipation	T _j =150°C , 1 device			120	W
T _j	Junction temperature	/			150	°C
T _{op}	Operating temperature	/	-40		150	°C
T _{stg}	Storage temperature	/	-40		150	°C
V _{iso}	Isolation between terminal and copper base	T _j =25°C , AC: 1minute	2500			V
I _{CES}	Zero gate voltage collector current	T _j =25°C , V _{CE} =1200V , V _{GE} =0V			0.1	mA
I _{GES}	Gate-Emitter leakage current	T _j =25°C , V _{CE} =0V , V _{GE} =±20V	-0.4		0.4	µA
V _{GE(th)}	Gate-Emitter threshold voltage	T _j =25°C , V _{CE} =20V , I _C =1.2mA	5.0	5.2	6.0	V
V _{CE(sat)}	Collector-Emitter saturation voltage	T _j =25°C , V _{GE} =15V , I _C =10A		2.0	2.5	V
		T _j =125°C , V _{GE} =15V , I _C =10A		2.15		V
		T _j =150°C , V _{GE} =15V , I _C =10A		2.25		V
Q _g	Gate Charge	T _j =25°C , V _{CE} =600V, I _C =10A, V _{GE} =15V		0.11		µC
R _{Gint}	Integrated gate resistor			3		Ω
C _{res}	Input capacitance	T _j =25°C , V _{CE} =25V , V _{GE} =0V , f=1MHz		1.4		nF
C _{res}	Reverse transfer capacitance			0.05		nF
t _{(d)on}	Turn-on time	T _j =150°C , V _{CC} =600V , I _C =10A , V _{GE} =±15V , R _g =30Ω (R _g =51Ω , T _j =125°C) , Inductive load		53		ns
t _r				62		ns
t _{(d)off}	Turn-off time			277		ns
t _f				212		ns
E _{on}	Turn-on energy loss per pulse	I _C =10 A , V _{CE} =600 V , L _S =50nH V _{GE} =±15 V , di/dt=550 A/µs (T _{vj} =150°C) R _{Gon} =39Ω		1.85		mJ
E _{off}	Turn-off energy loss per pulse			1.23		mJ
I _{sc}	SC data	V _{GE} ≤15 V , V _{CC} =800V , V _{CEmax} =V _{CES} -L _{SCE} ·di/dt , t _P ≤10µs , T _{vj} =150°C		55		A
t _{sc}	Short circuit withstand time	V _{CES} ≤600V, V _{GE} =±15V , R _g =30 Ω		10		µs

V _F	Forward on voltage	T _J =25°C ,I _F =10A	2.1	2.3	V
		T _J =125°C ,I _F =10A	2.2		V
		T _J =150°C ,I _F =10A	2.2		V
I _{FRM}	Repetitive peak forward current		23		A
Q _r	Recovered charge	I _F =10 A, -diF/dt=550 A/μs (T _{vj} =150°C), V _R =600V, V _{GE} =-15V, T _J =150°C	2.40		μC
E _{rec}	Reverse recovery energy	I _F =10A, -diF/dt=550 A/μs (T _{vj} =150°C), V _R =600V, V _{GE} =-15V, T _J =150°C	0.80		mJ
t _{rr}	Reverse recovery time	T _J =25°C ,I _F =10A, diF/dt=-1600A/ μ s, V _R =600V	150		ns
R _{th(j-c)}	Thermal resistance(per chip)	IGBT	0.82		°C/W
		FWD	2.53		°C/W
R _{th(c-f)}	Contact thermal resistance (per module)	With thermal compound	0.06		°C/W
R ₂₅	Resistance	T _{vj} =25°C	5		kΩ
ΔR/R	Deviation of R100	T _C =100°C, R ₁₀₀ =493W	-5	5	%
P ₂₅	Power dissipation	T _C =25°C		20.0	mW
B _{25/50}	B-value	R ₂ =R ₂₅ exp [B _{25/50} (1/T ₂ -1/(298,15K))]	3375		K
B _{25/80}		R ₂ =R ₂₅ exp [B _{25/80} (1/T ₂ -1/(298,15K))]	3411		K
B _{25/100}		R ₂ =R ₂₅ exp [B _{25/100} (1/T ₂ -1/(298,15K))]	3433		K
Screw torque	Mounting force per clamp (M4)	/	1.5	2.5	N·m
W _t	Weight		24		g
Outline	258H5P				

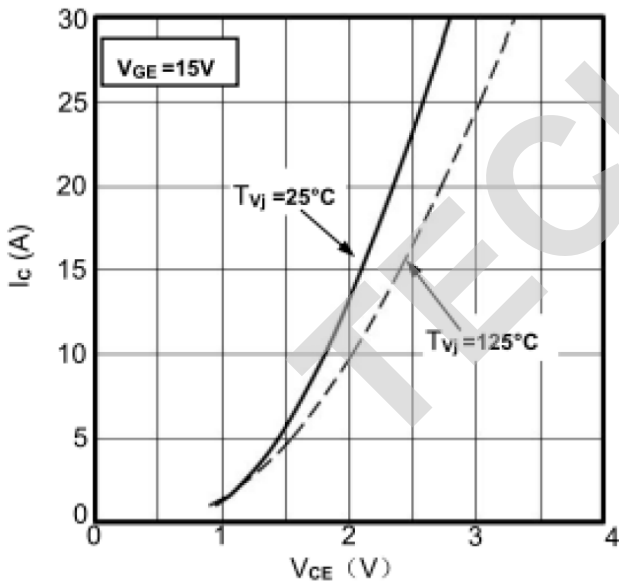

Figure1. Typical Output Characteristics

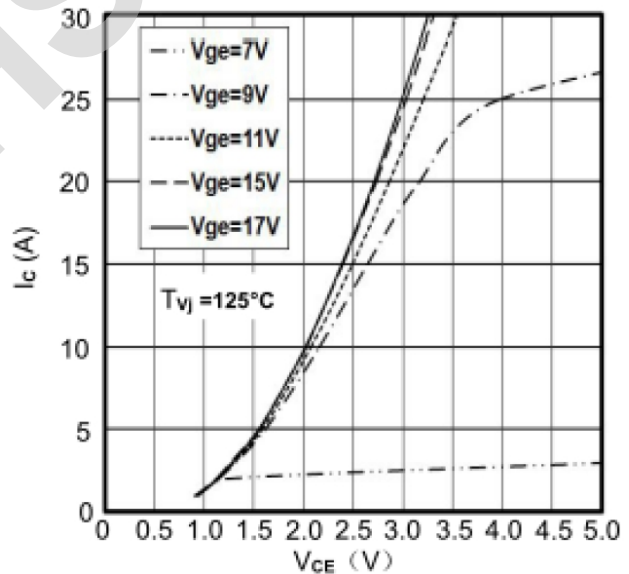

Figure2. Typical Output Characteristics

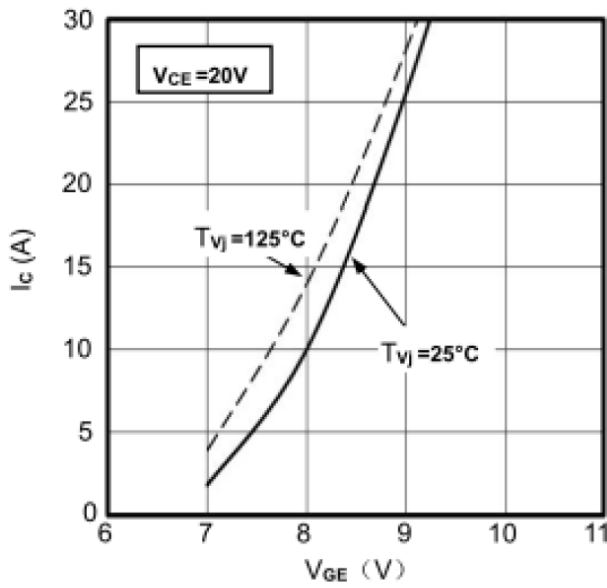

Figure3. Typical Transfer characteristics

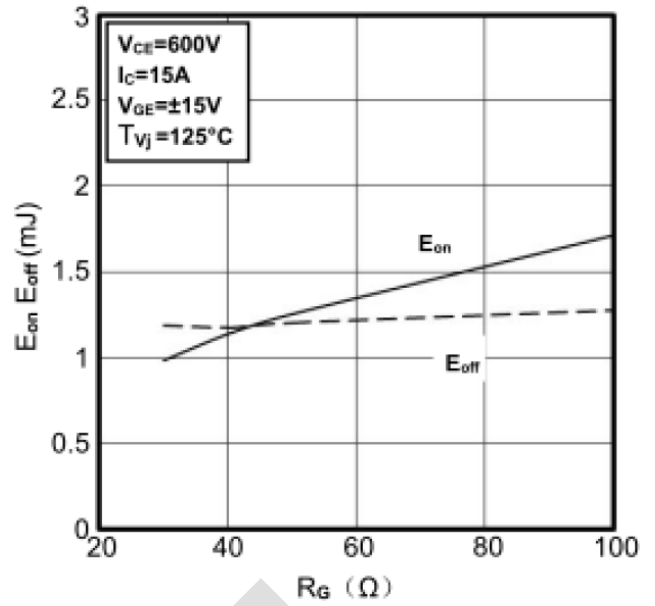

Figure4. Switching Energy vs. Gate Resistor

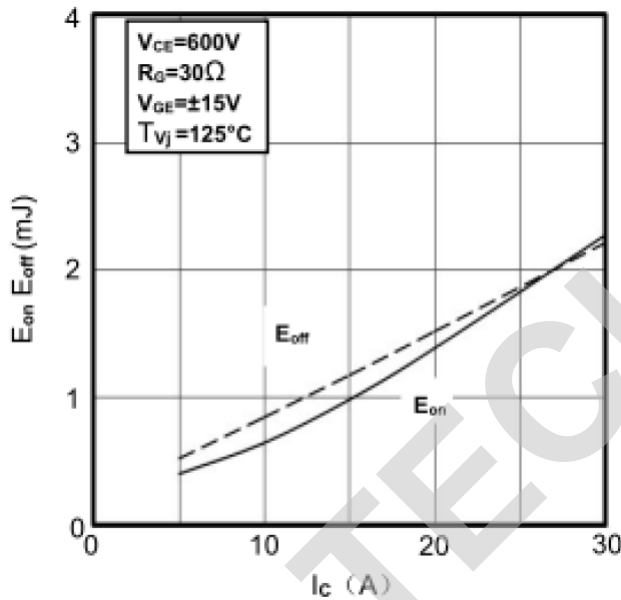

Figure5. Switching Energy vs. Collector Current

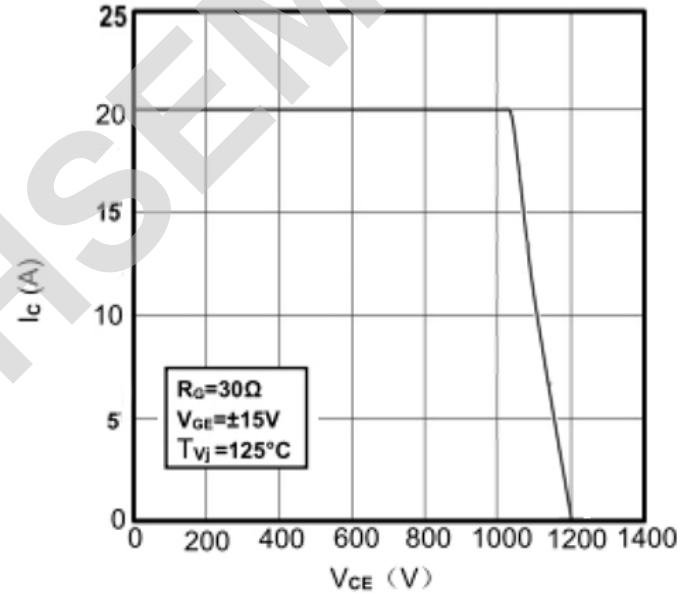

Figure6. Reverse Biased Safe Operating Area

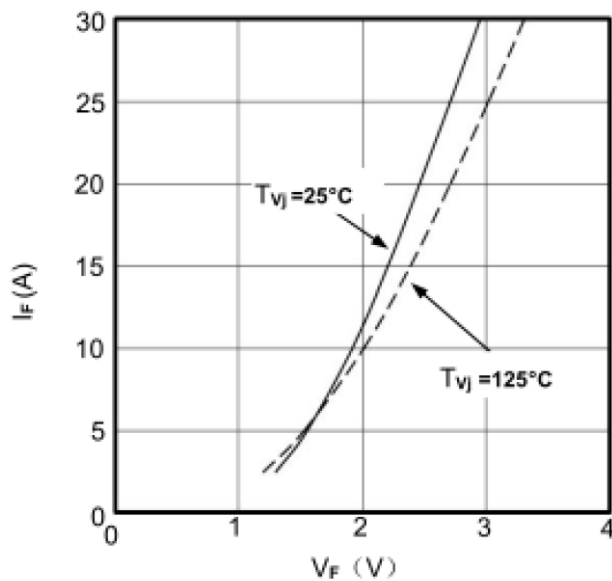

Figure7. Diode Forward Characteristics

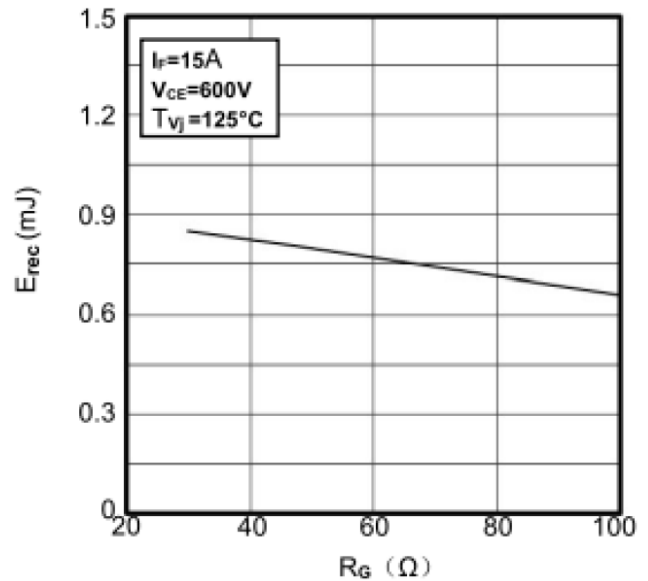

Figure8. Switching Energy vs. Gate Resistor

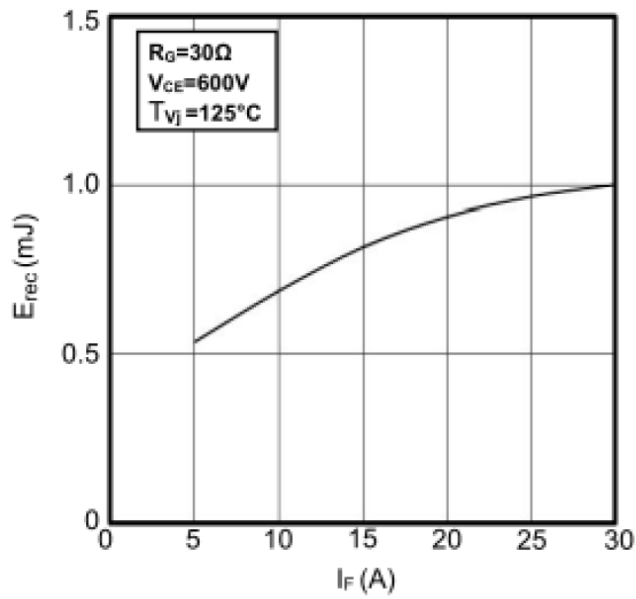

Figure9. Switching Energy vs. Forward Current

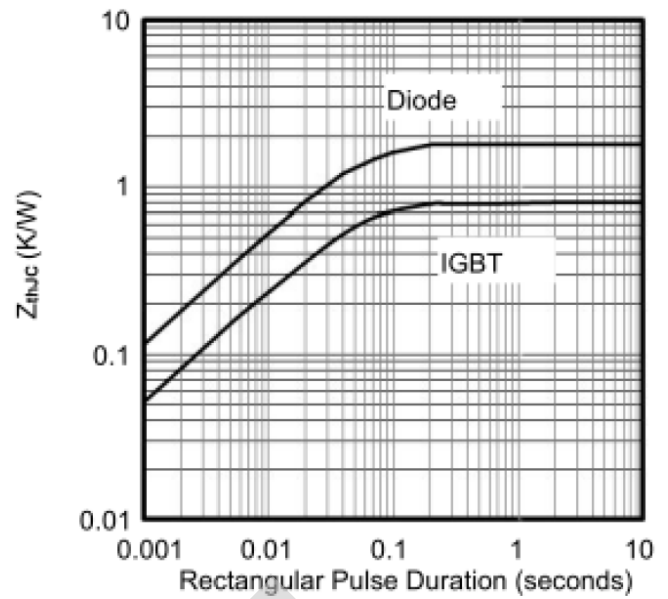

Figure10. Transient Thermal Impedance

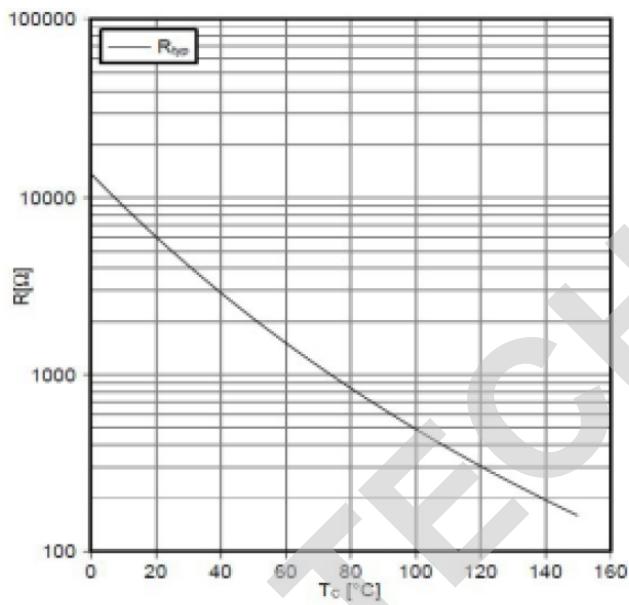
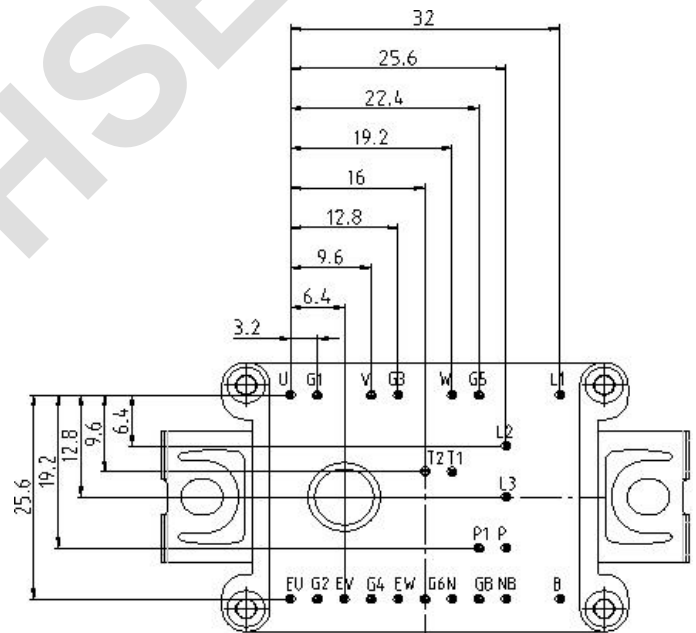
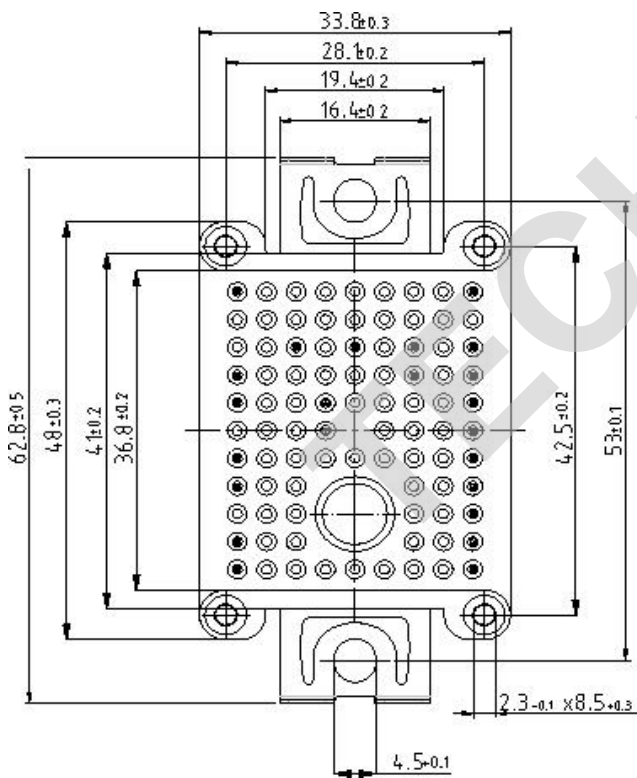
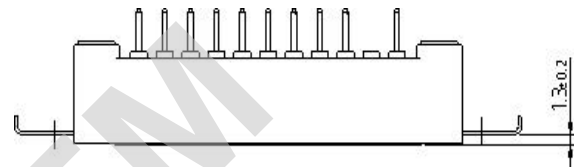
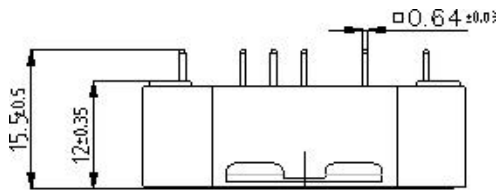
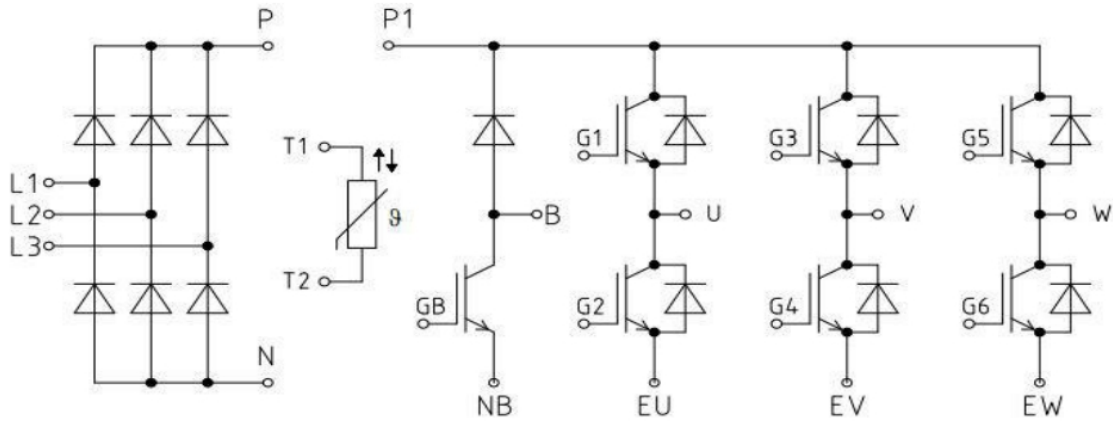

Figure11. NTC-Thermistor-temperature characteristic

Outline & Circuit Diagram



Unmarked dimensional tolerance: $\pm 0.5\text{mm}$

TECHSEM reserves the right to change specifications without notice.